

PTH

Africa Gabon hotel

1. Date : 2011
2. Location : Gabon
3. Scale : 9350m²
4. Category : Steel Structure Building
5. Function : Hotel
6. Characteristics : Perfect fusion of traditional steel structure and new light steel structure, the main frame adopts traditional steel structure, and the roof and wall maintenance system adopts light steel keel



项目设计



PTH owns 100+ architect and engineers at home and abroad, to provide customized design service for client with different requirements. We use the relevant information data of construction projects as the basis of the model to build the building model, and simulate the real information of the building through digital information simulation.

At present, we have finished the Revit research and development of company's products, laying a solid foundation to finish design effectively and accurately and also presenting details and three dimensional effects of our company's products to customers.

Project features: The project is located in two identical hotels in Gabon (Libreville and Francsville) in Africa, mainly for the 2012 African Football Cup participants. The hotel consists of 2 main buildings with 3 floors and 3 annex buildings with 1 floor. After the prefabricated parts are produced in the PTH factory in China, they are directly transported to the local area for installation. PTH sent a professional construction and installation team of more than 100 people to install.

The project perfectly combines traditional steel structure and new light steel structure. The main frame adopts traditional steel structure, and the roof and wall maintenance system adopts light steel keel. The PTH team provides customers with a whole process from design, procurement, production and installation. Dragon service.

DESIGN

The preliminary design is made in accordance to client' s requirement and local building code. After getting the permission by local authority, PTH will do the shop drawing for production.



Design

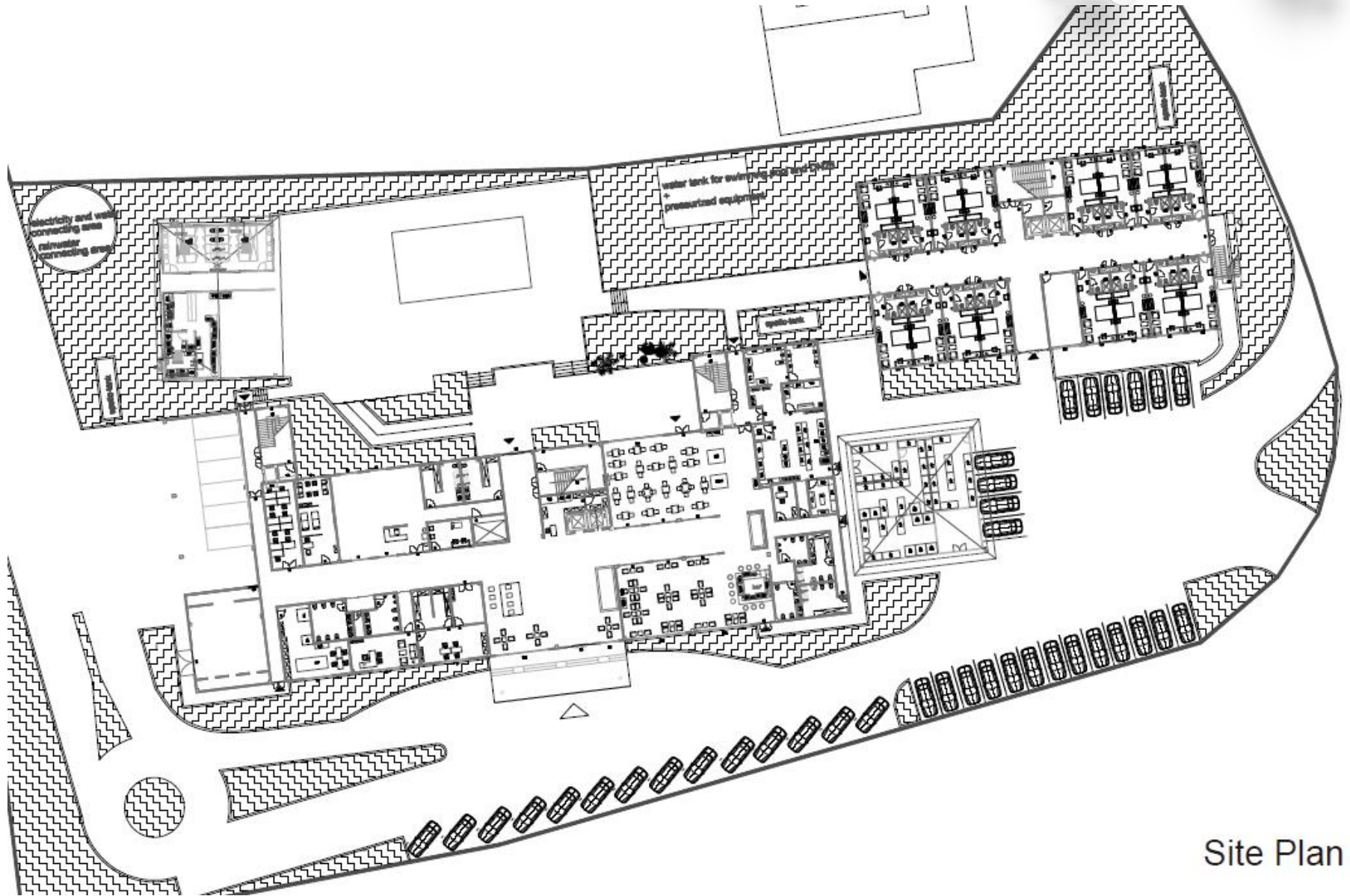

Site Plan

Design

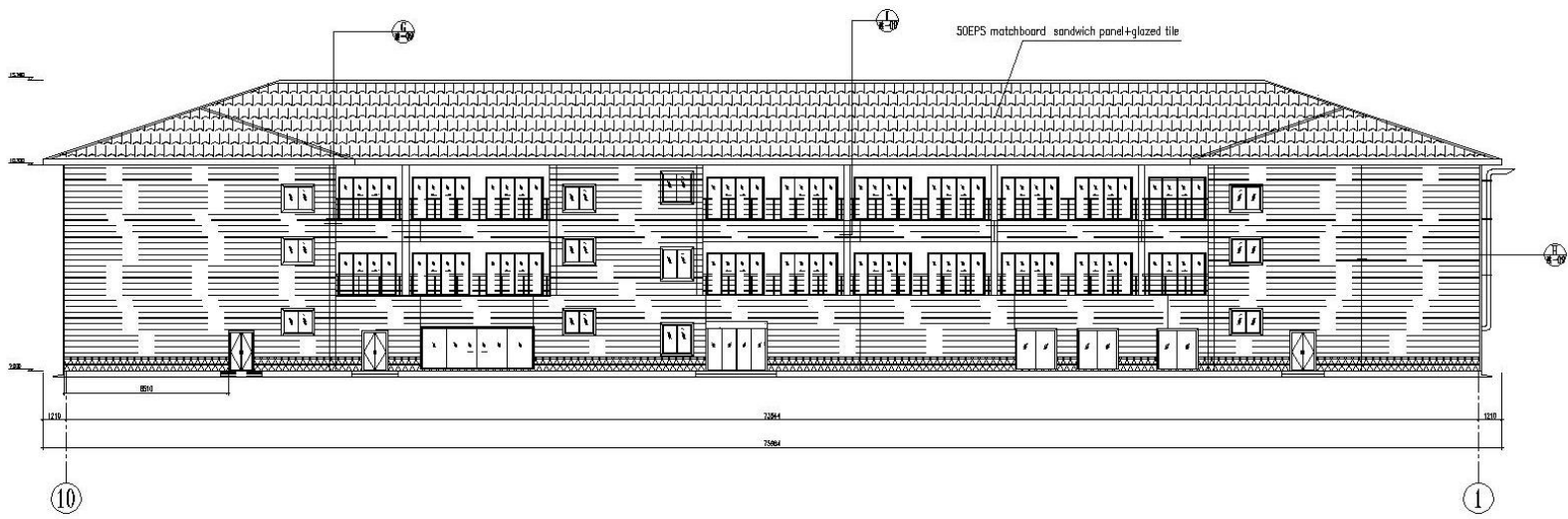
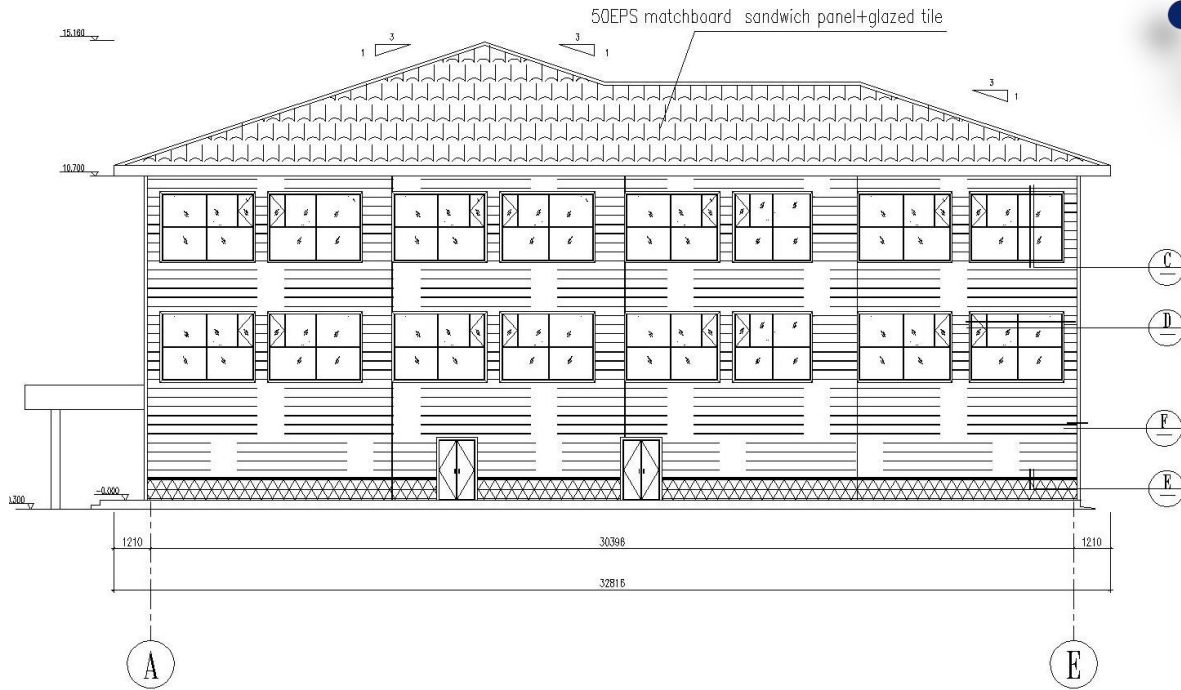

Production Drawing

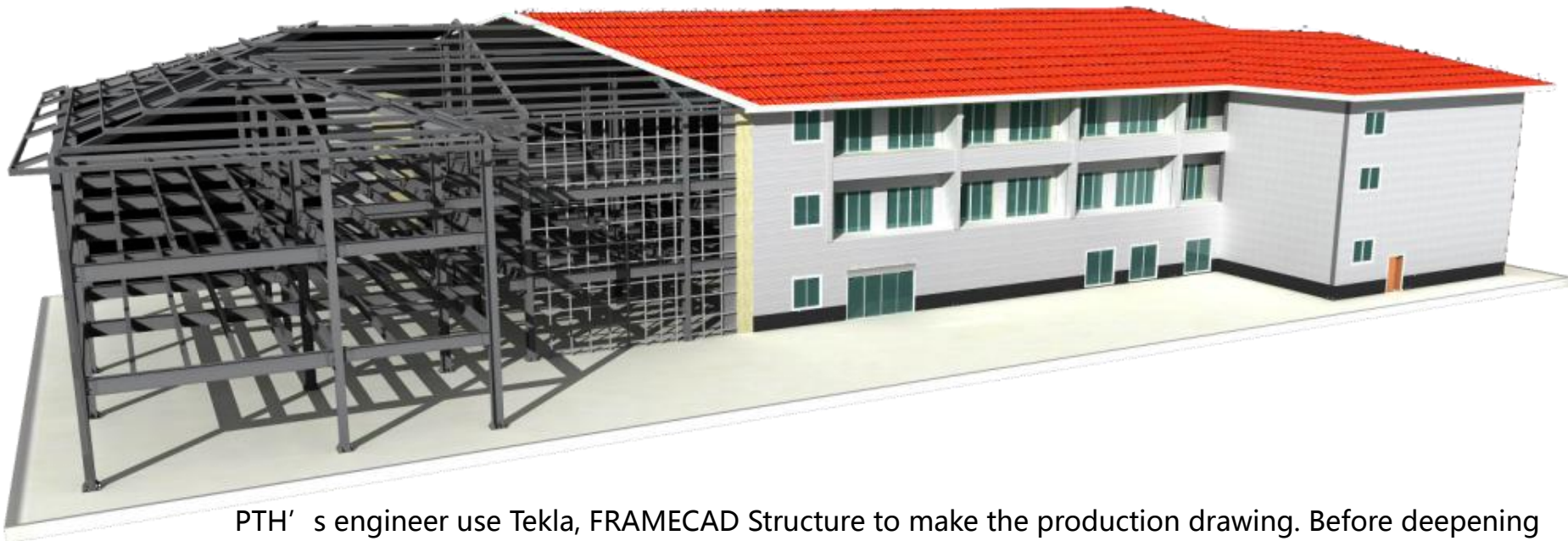

PTH' s engineer use Tekla, FRAMECAD Structure to make the production drawing. Before deepening the design, the technical information of the design drawings will be reviewed to see if they meet the requirements, and then the production drawings will be produced according to the final design drawings.

When deepening the design, we must ensure that the product assembly size deviation standards, welding quality technical requirements, structural connection nodes, product anti-corrosion technology, etc. meet the design technical specifications.

Production drawing

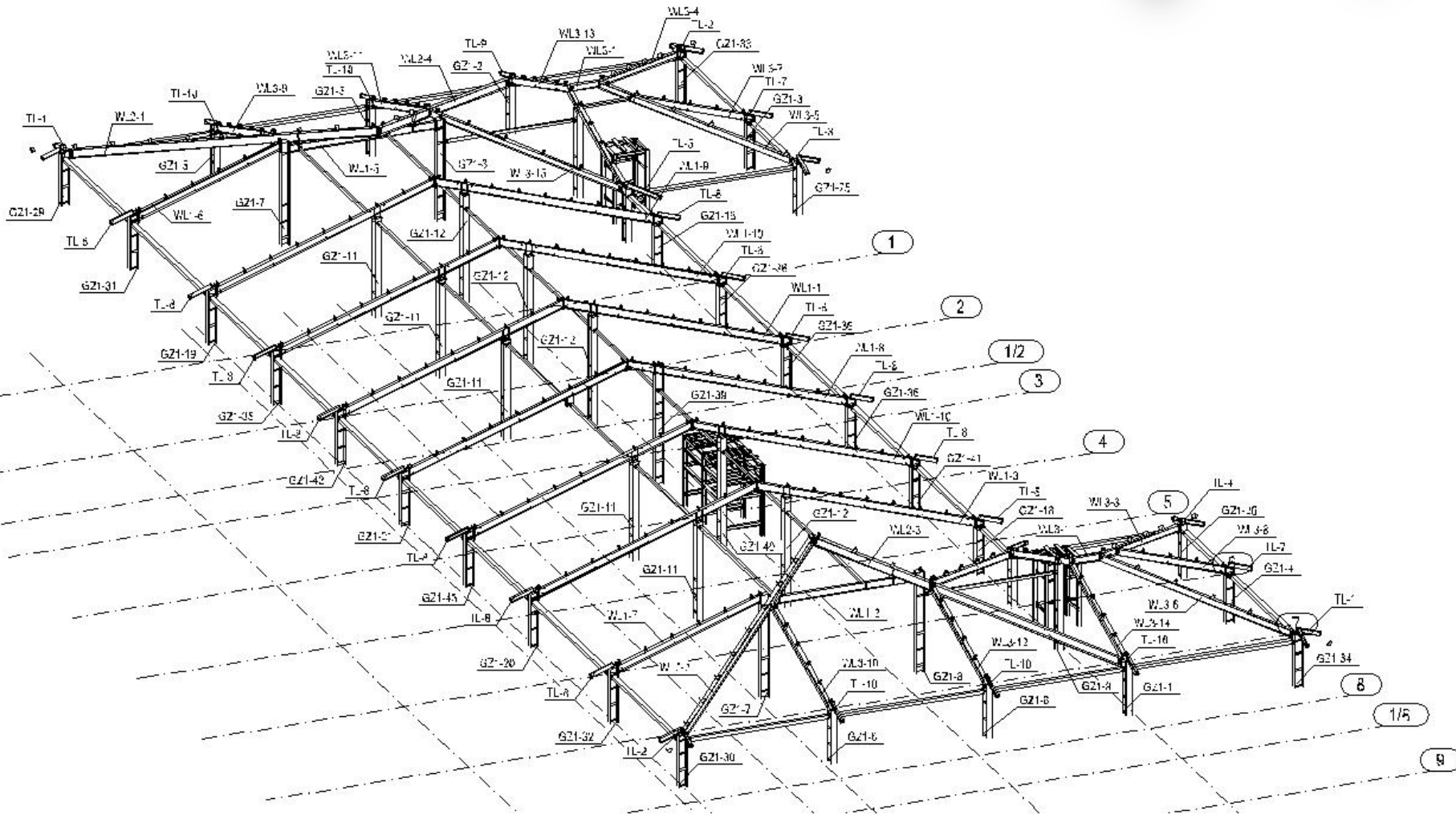

Production drawing

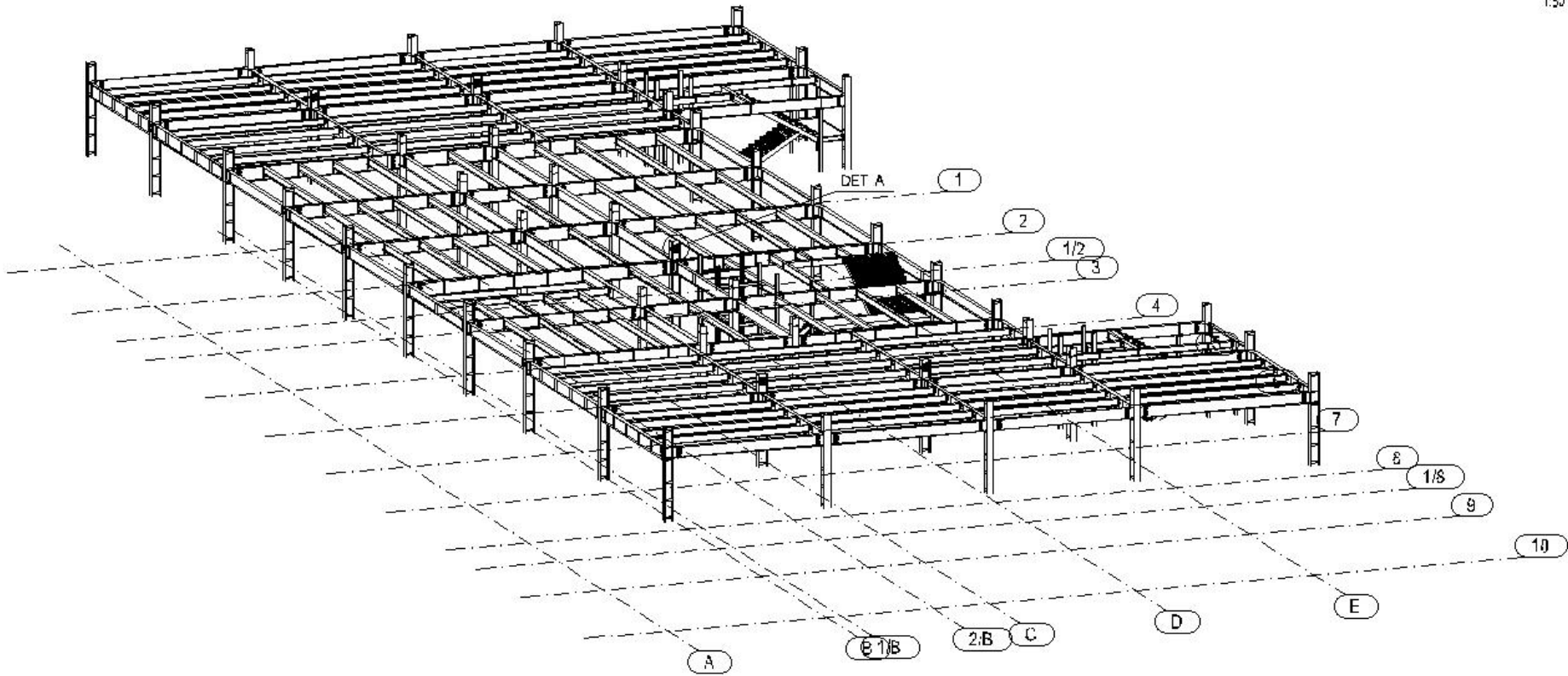

3D draing for 2 floor



Production drawing

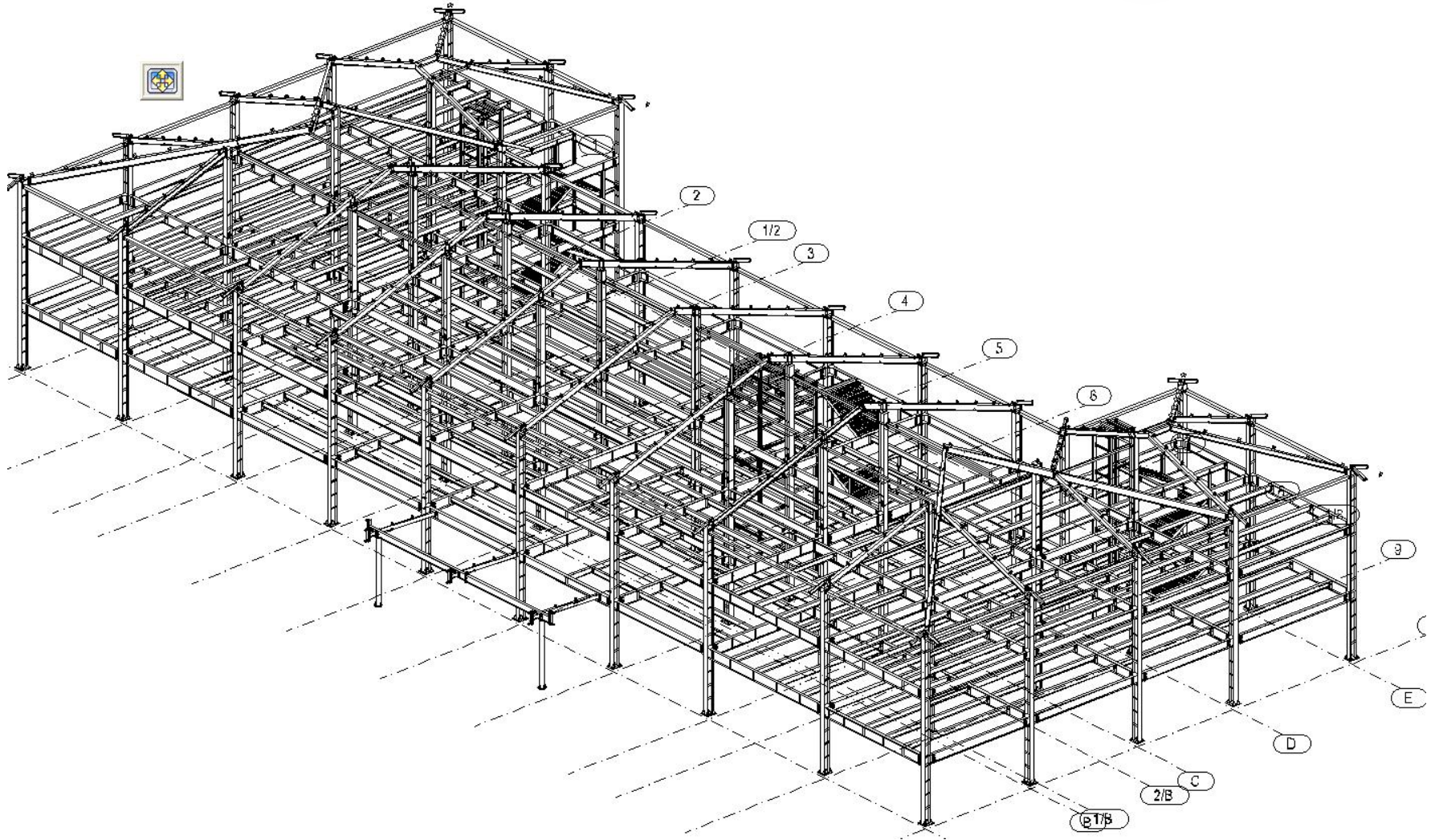

Production drawing

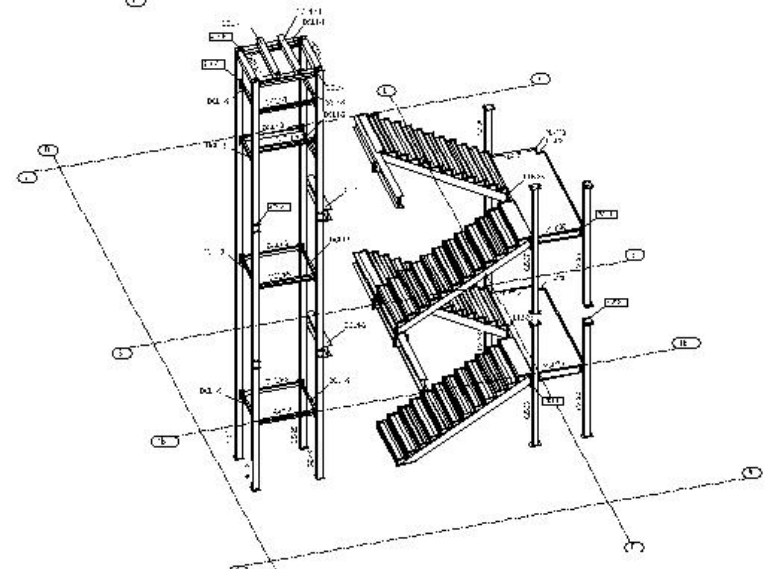
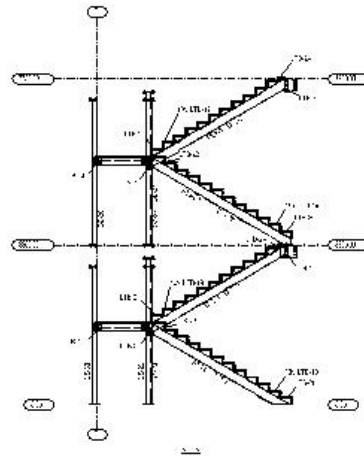
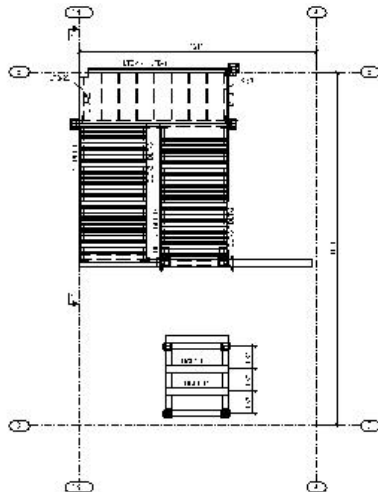
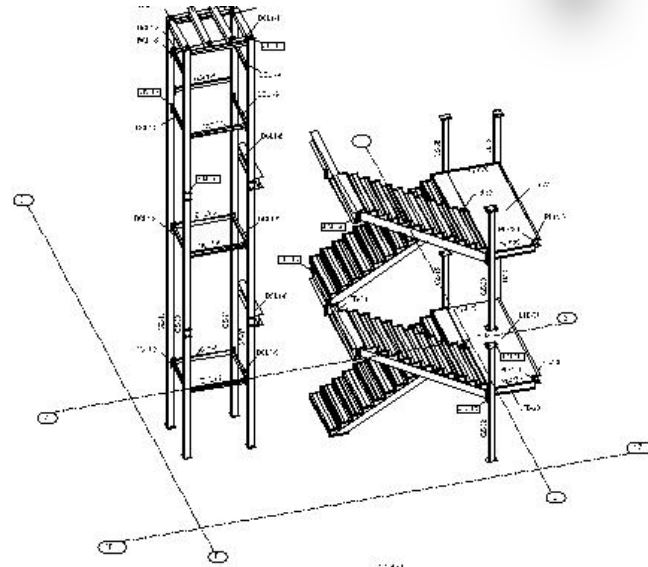
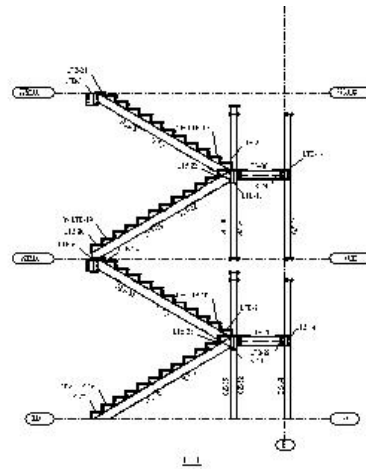
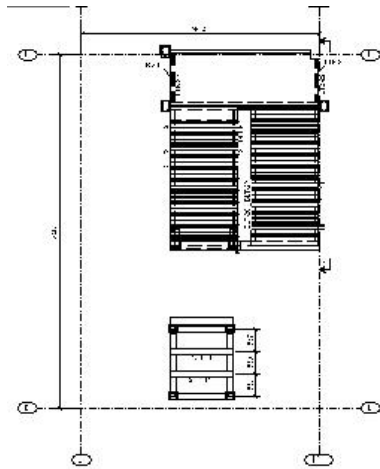

PRODUCTION & DELIVERY



PROCUREMENT :

PTH has a mature procurement supply chain, including product raw materials, kitchen and bathroom accessories, home equipment and other supporting facilities. Each year, PTH conducts quality assessments of suppliers, resolutely rejects unqualified suppliers, and guarantees the quality of products from the source.



PRODUCTION :

PTH owns hundreds of fully automatic mechanized production line, which ensures high production efficiency and timely delivery. In the manufacturing process, PTH can provide production progress reports to customers through pictures and video.

PTH has a professional quality inspection team which takes strict quality control in each process, and make sure defect product never be delivered to client.

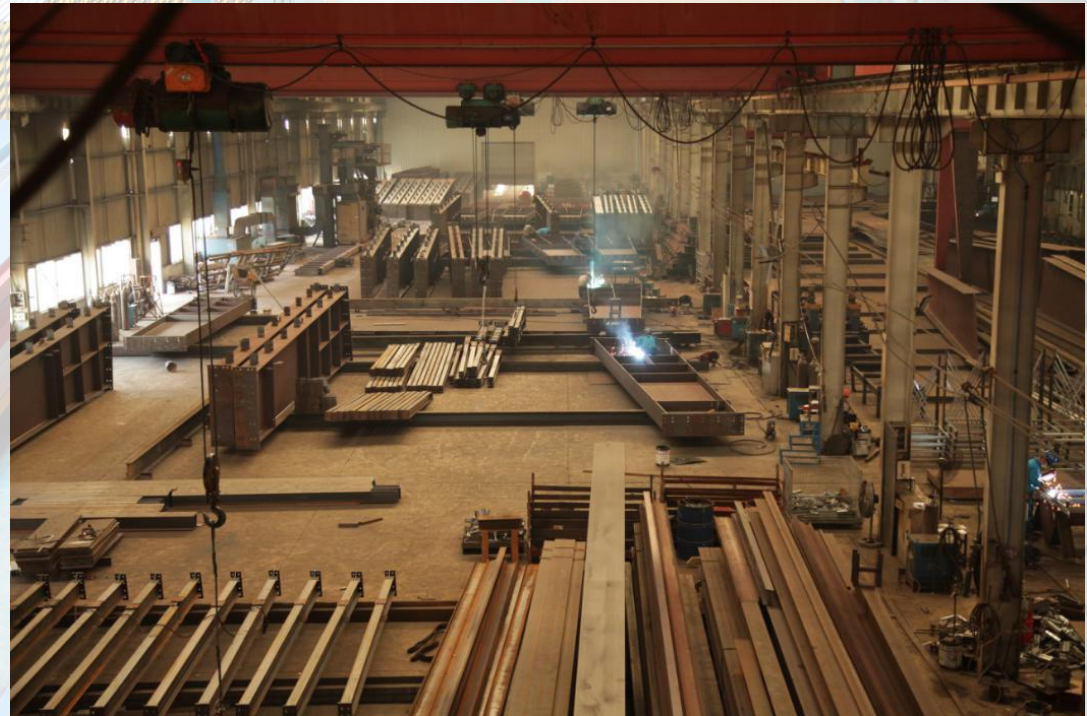

TRANSPORTATION :

PTH, who has more than 20 years of international logistics experience. can provide customers with the best transportation routes, customs declaration, commodity inspection and other services, and truly realizes "door to door."

PRODUCTION PICTURES



Quality is the life of a enterprise and the foundation of sustainable development. PTH strictly follows the ISO9000 quality system and make quality control in each process from material procurement to finish product delivery.

For the outsourcing raw material and accessories, it is reported to the ICQC team for inspection. ICQC will inspect according to “Raw Material Inspection Regulations” , make sure the material technical specs and quality meets GB standard, then upload the inspection record, QC document and test report to ERP system.

PRODUCTION PICTURES

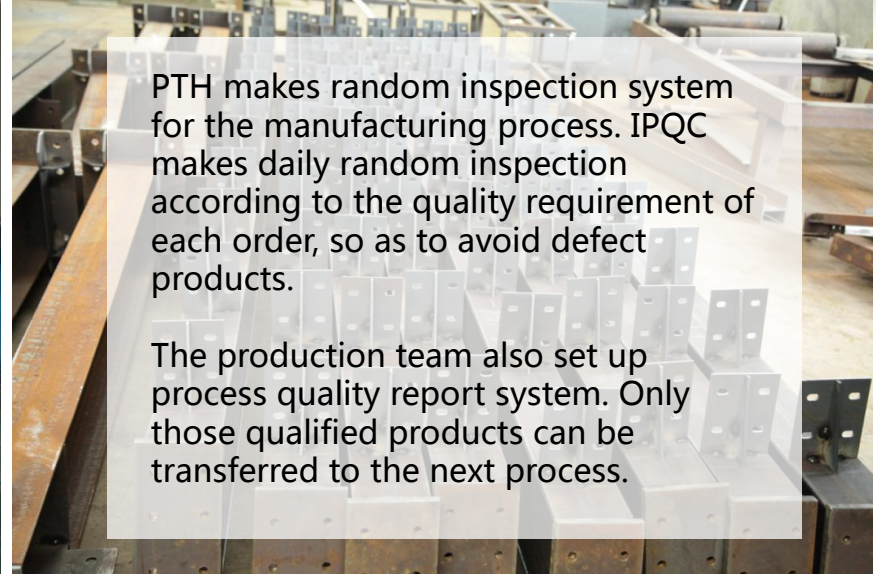

PTH makes random inspection system for the manufacturing process. IPQC makes daily random inspection according to the quality requirement of each order, so as to avoid defect products.

The production team also set up process quality report system. Only those qualified products can be transferred to the next process.



PACKAGE & LOADING



PTH makes the most reasonable package plan according to the structure characteristics and quality requirement. The modular package design of the spare part effectively reduce the package volume. The spare parts of each module is packed in a separate package, these small package modular combination ensures a easy transportation and installation, which in return makes the loading and unloading much easier, and greatly reduces labor cost.



PACKAGE & LOADING



INSTALLATION



PTH will provide complete and detailed installation drawings for the product. PTH has professional photography and post-production personnel who can provide installation videos for the product and intuitively demonstrate the installation steps and installation details of the product.

PTH owns on-site installation guidance experience for dozens of projects such as Mozambican light steel villa resorts, Chilean container camps, etc. It can provide EPC construction services and technical guidance according to the needs of customers to ensure the smooth and safe construction of the houses required by customers and realize real "Check-in".

INSTALLATION



URL : www.pthhouse.com / www.putianhouse.com
E-mail : inquiry@putianhouse.com

INSTALLATION



URL : www.pthhouse.com / www.putianhouse.com
E-mail : inquiry@putianhouse.com

CLIENT FEEDBACK



We use BIM system to manage and operate the whole project. For the maintenance, PTH provide online technical support or maintenance service on the site per client requirement.

Customers have worked with us on steel structure and container projects before. They are very satisfied with our profession and quality, so this big project also continues to cooperate with us. After the project is installed, customers are very satisfied with our main frame.



INSTALLATION



**URL : www.pthhouse.com / www.putianhouse.com
E-mail : inquiry@putianhouse.com**

INSTALLATION



**URL : www.pthhouse.com / www.putianhouse.com
E-mail : inquiry@putianhouse.com**